





A*1pc	B*1pc	C*2pcs	D*2pcs	E*2pcs
				

Step 1: Top and Bottom board

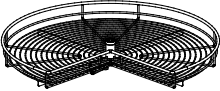
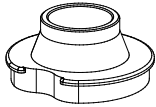

Step 2:

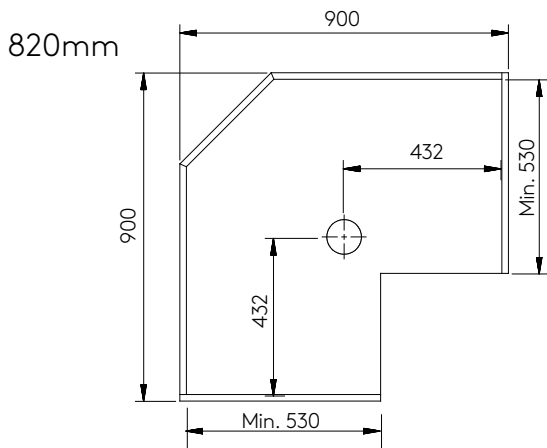
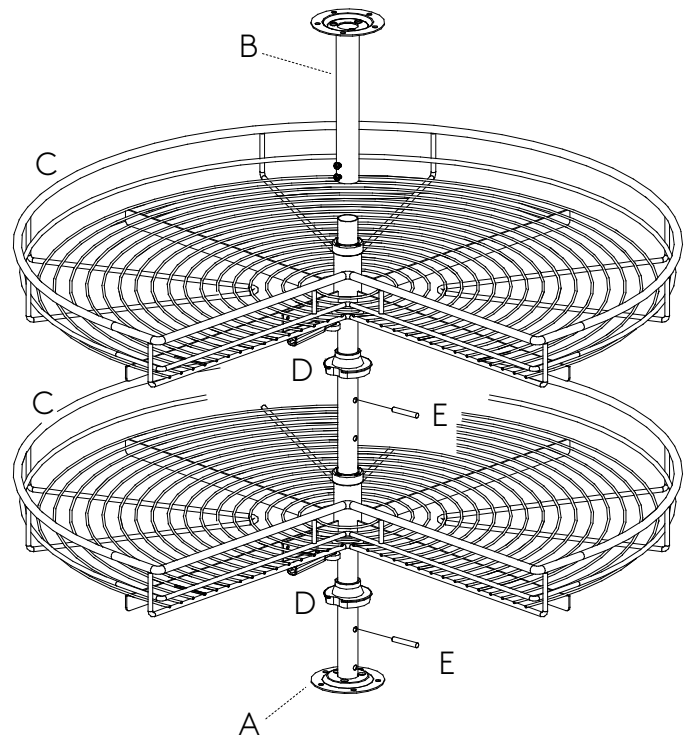

Finished:

